

Kabel type A:	min. 3x1.5 mm ²
Kabel type B:	min. 4x0.75 mm ²
Kabel type C:	min. 3x0.8 mm
Kabel type D:	min. 2x0.8 mm (skærmet + parsnoet)
Kabel type E:	min. 2x0.8 mm
Kabel type H:	min. 4x0.8 mm (skærmet + parsnoet)

Relæbokse og central skal forsynes fra egne grupper.
 Installationen skal udføres i.h.t. til maskindirektivet.

		Forhandles af:		
		Blendex A/S Fischer Danmark A/S	blendex.dk fischer-danmark.dk	
Sag: Principdiagram SynSync 240		Mål: -	Revision:	Sags.nr.: STANDARD
Emne: Oversigtsdiagram 4 zoner		Dato: 11.11.17	D:	
		Sign.: PC	E:	
				Tegn.nr.: 240-01

Data:

1. Spænding: 230V./ 10A 50Hz
2. Styrespænding: Svagstrøm IB signal
3. Motorudgang max. 250V. / 3,15 Amp pr. udgang
4. Temperaturområde: 0 - 40°C (monteres indendørs)

NB:

Motorer må ikke parallelkobles!
Kun een motor pr. udgang!

HUSK at kontrollere indstilling af switches!!

Switch S1				
Mode	1	2	3	4
Normal	OFF	OFF	OFF	OFF
IDS	ON	OFF	OFF	ON

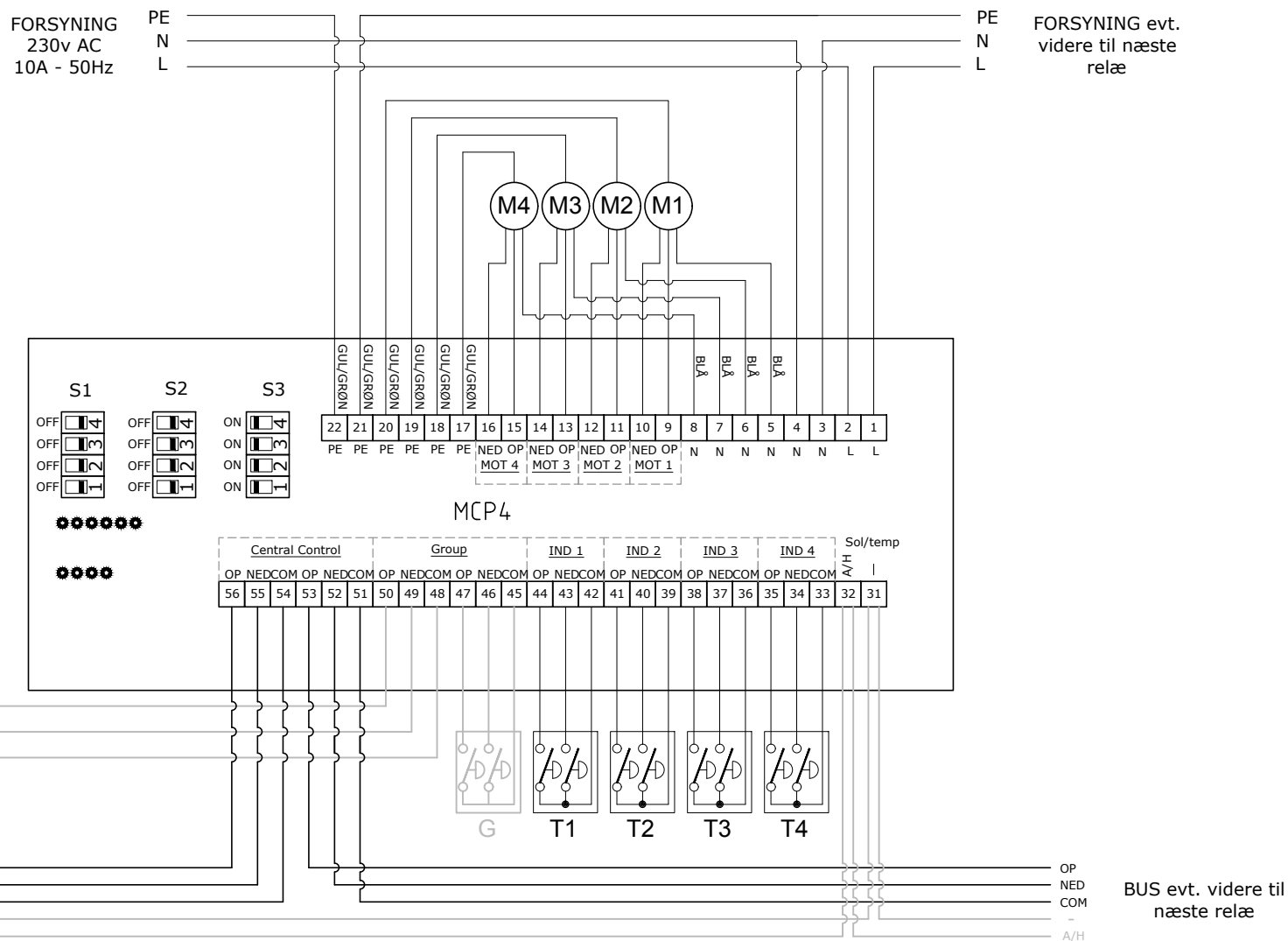

Relæboks og central skal forsynes fra egne grupper.
Installationen skal udføres i.h.t. til maskindirektivet.

		Forhandles af:		
		Blendex A/S Fischer Danmark A/S	blendex.dk fischer-danmark.dk	
Sag: Principdiagram SunSync 240			Revision:	Sags.nr.:
Emne:		Mål:	A:	Standard
Tilslutningsdiagram MCP4		Dato: 11.11.17	B:	
		Sign.: PC	C:	Tegn.nr.:
			D:	240-03
			E:	

Data:

1. Spænding: 230V./ 10A 50Hz
2. Styrespænding: Svagstrøm IB signal
3. Motorudgang max. 250V. / 3,15 Amp pr. udgang
4. Temperaturområde: 0 - 40°C (monteres indendørs)

NB:
Motorer må ikke
parrallelkobles!
Kun een motor pr.
udgang!

**HUSK at kontrollere indstilling af
switches!!**

Switch S1				
Mode	1	2	3	4
Normal	OFF	OFF	OFF	OFF
IDS	ON	OFF	OFF	ON

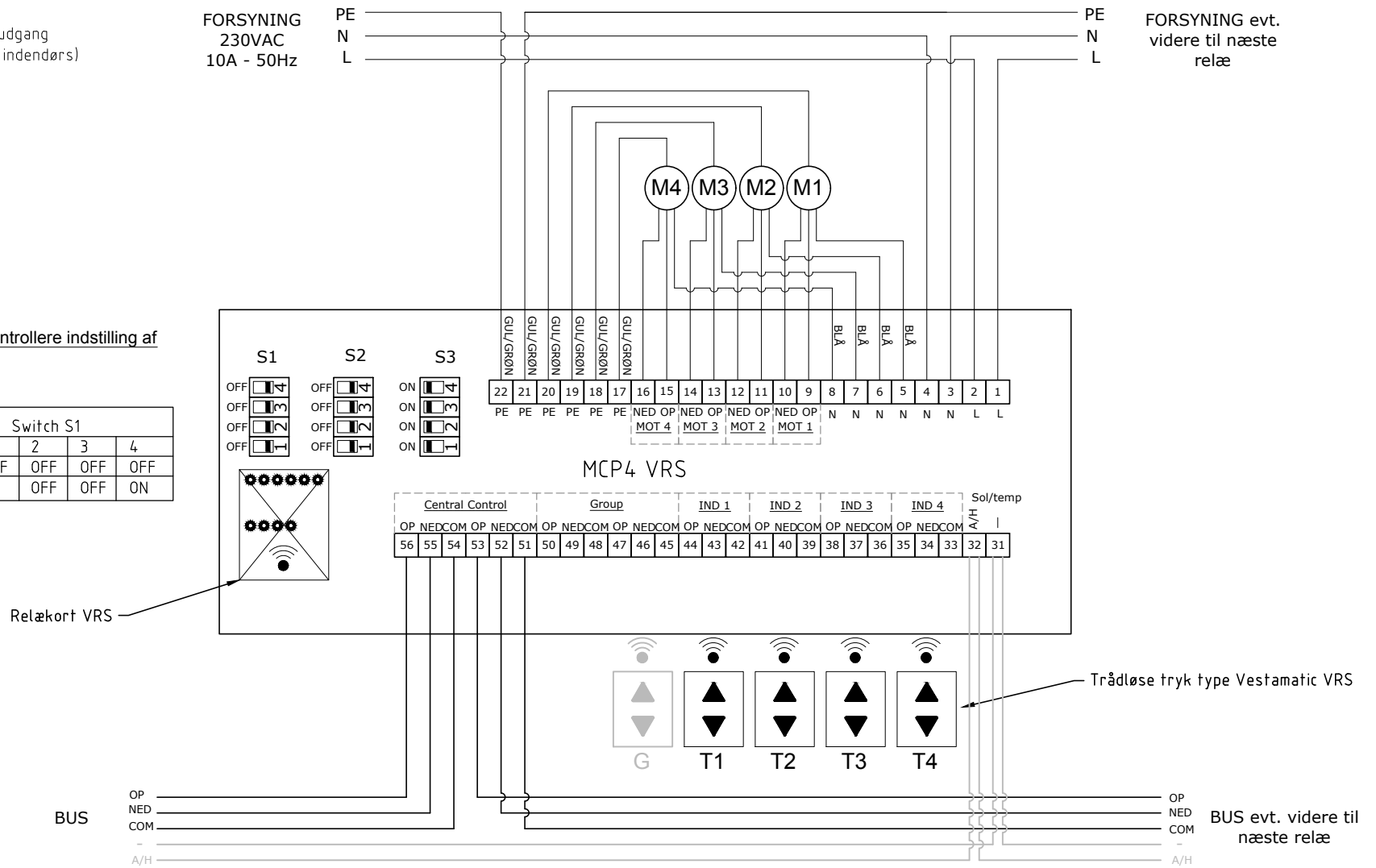

Relæboks og central skal forsynes fra
egne grupper.
Installationen skal udføres i.h.t. til
maskindirektivet.

		Forhandles af:		
		Blendex A/S Fischer Danmark A/S	blendex.dk fischer-danmark.dk	
Sag: Principdiagram SunSync 240			Revision:	Sags.nr.:
Emne:		Mål:	A:	Standard
Tilslutningsdiagram MCP4 med trådløse tryk		Dato: 11.11.17	B:	
		Sign.: PC	C:	Tegn.nr.:
			D:	240-04
			E:	

Data:

1. Spænding: 230V./ 10A 50Hz
2. Styringspænding: Svagstrøm IB signal
3. Motorudgang max. 250V. / 3,15 Amp pr. udgang
4. Temperaturområde: 0 - 40°C (monteres indendørs)

NB:

Motorer må ikke
parrallelkobles!
Kun een motor pr.
udgang!

**HUSK at kontrollere indstilling af
switches!!**

Switch S1				
Mode	1	2	3	4
Normal	OFF	OFF	OFF	OFF
IDS	ON	OFF	OFF	ON

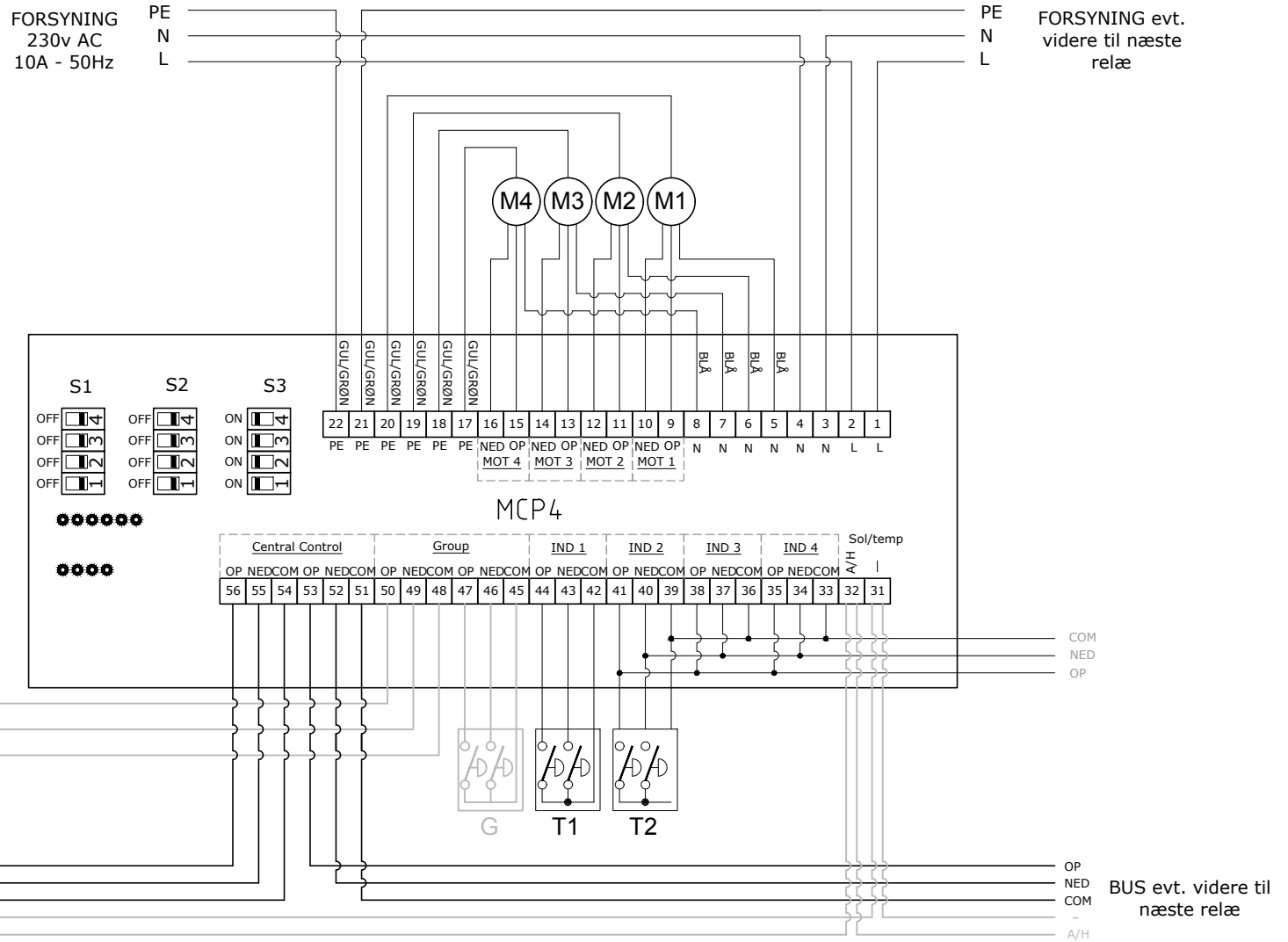

Relæboks og central skal forsynes fra
egne grupper.
Installationen skal udføres i.h.t. til
maskindirektivet.

		Forhandles af:		
		Blendex A/S Fischer Danmark A/S	blendex.dk fischer-danmark.dk	
Sag: Principdiagram SunSync 240			Revision:	Sags.nr.:
Emne:		Mål:	A:	Standard
Tilslutningsdiagram MCP4		Dato: 11.11.17	B:	
Flere motorer på 1 tryk		Sign.: PC	C:	Tegn.nr.:
			D:	240-05
			E:	

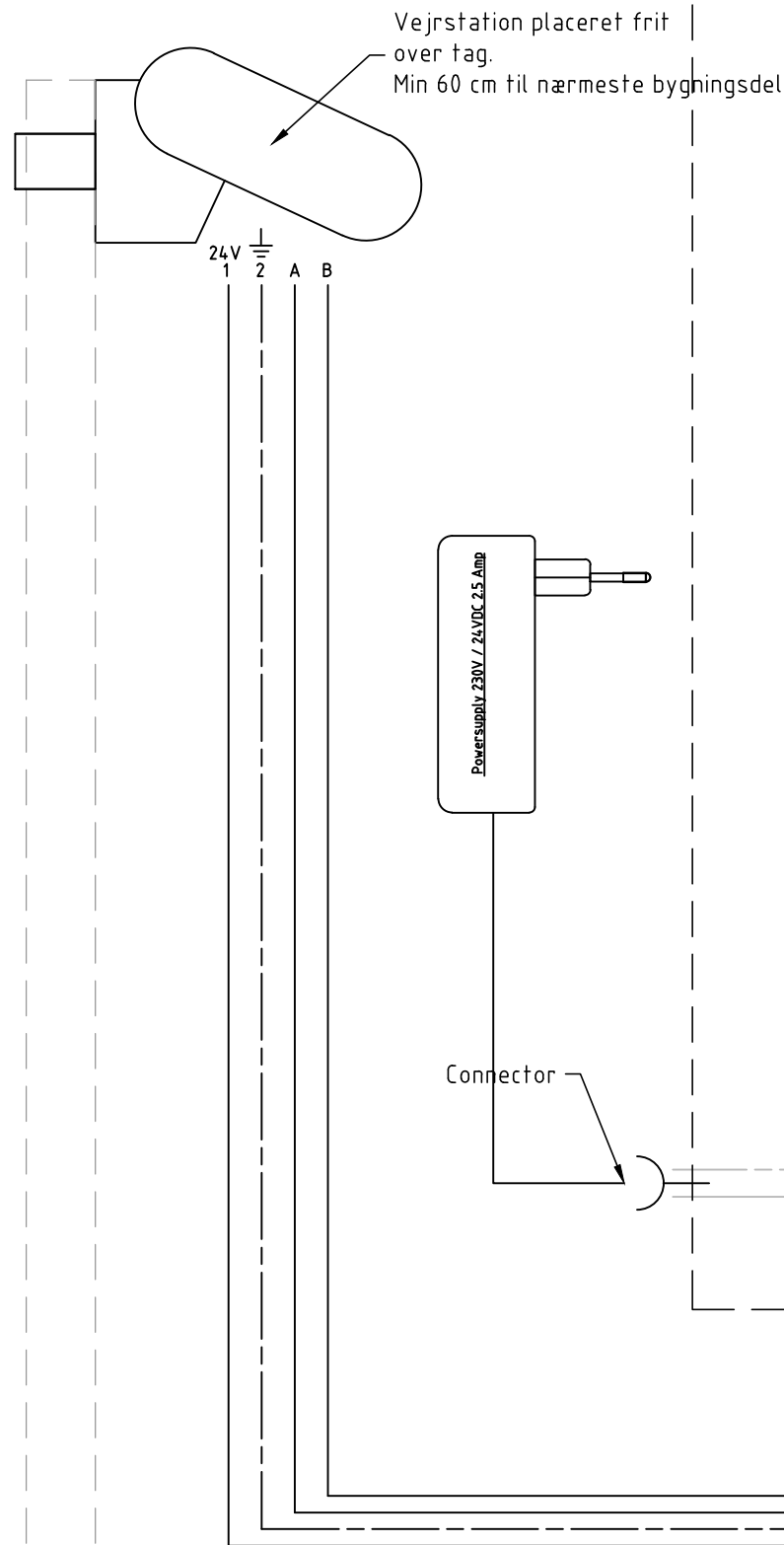

Kabel type A:	min. 3x1.5 mm ²
Kabel type B:	min. 4x0.75 mm ²
Kabel type C:	min. 3x0.8 mm
Kabel type D:	min. 2x0.8 mm (skærmet + parsnoet)
Kabel type E:	min. 2x0.8 mm
Kabel type H:	min. 4x0.8 mm (skærmet + parsnoet)

Relæboks og central skal forsynes fra egne grupper.
Installationen skal udføres i.h.t. til maskindirektivet.

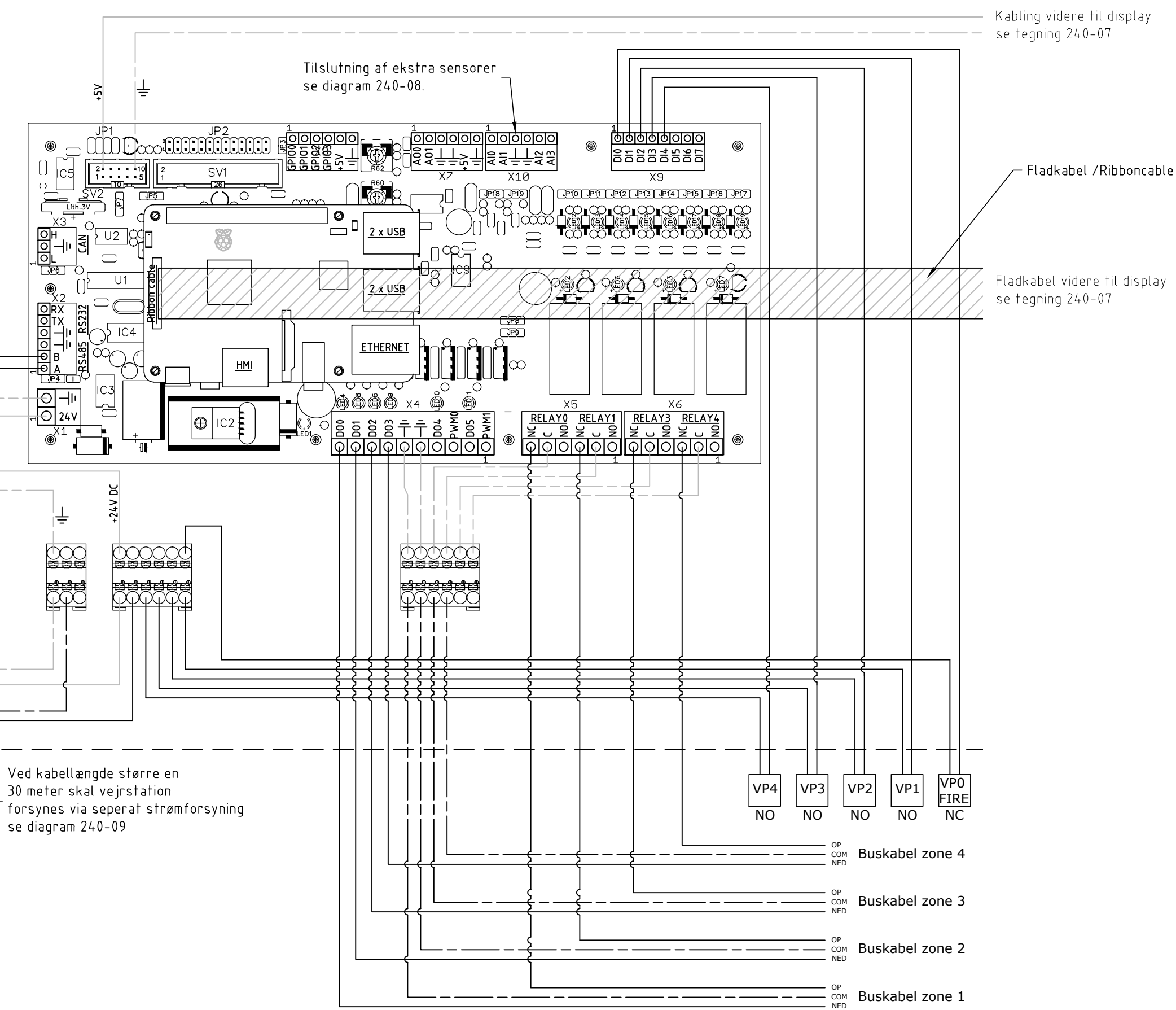

		Forhandles af:		
		Blendex A/S Fischer Danmark A/S	blendex.dk fischer-danmark.dk	
Sag: Principdiagram SynSync 240		Mål: — Dato: 11.11.17 Sign.: PC	Revision: A: 11.10.18	Sags.nr.: STANDARD
Emne: Tilslutningsdiagram Sunsync 240 printkort			D: —	
			E: —	Tegn.nr.: 240-06

Kabling videre til printkort
se tegning 240-06

Fladkabel / Ribboncable

Fladkabel videre til print
se tegning 240-06

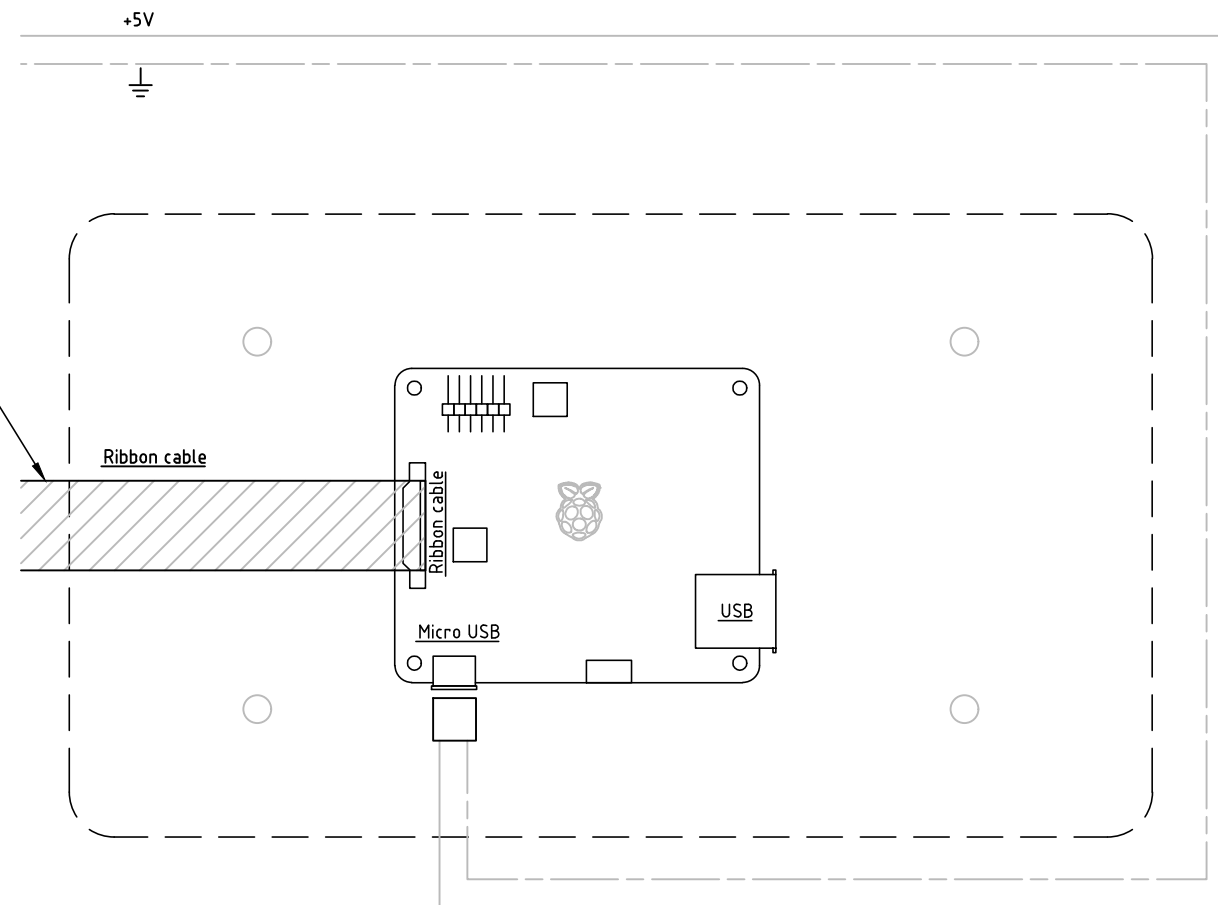

sunsync™

Forhandles af:

Blendex A/S
Fischer Danmark A/S

blendex.dk
fischer-danmark.dk

Sag: Principdiagram SynSync 240

Revision:

Sags.nr.:

Emne:

Tilslutningsdiagram Sunsync 240
touch display

Mål: -

A:

STANDARD

Dato: 11.11.17

B:

Tegn.nr.:

Sign.: PC

C:

240-07

D:

E:

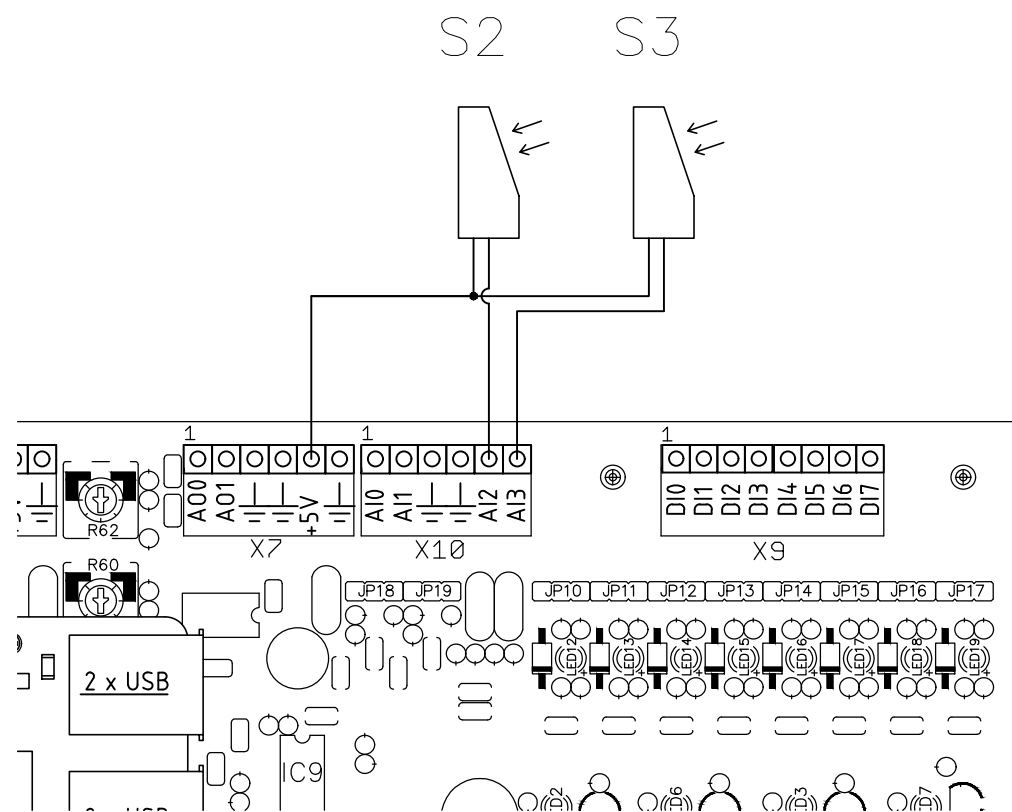

Tilslutning af ekstra solsensorer

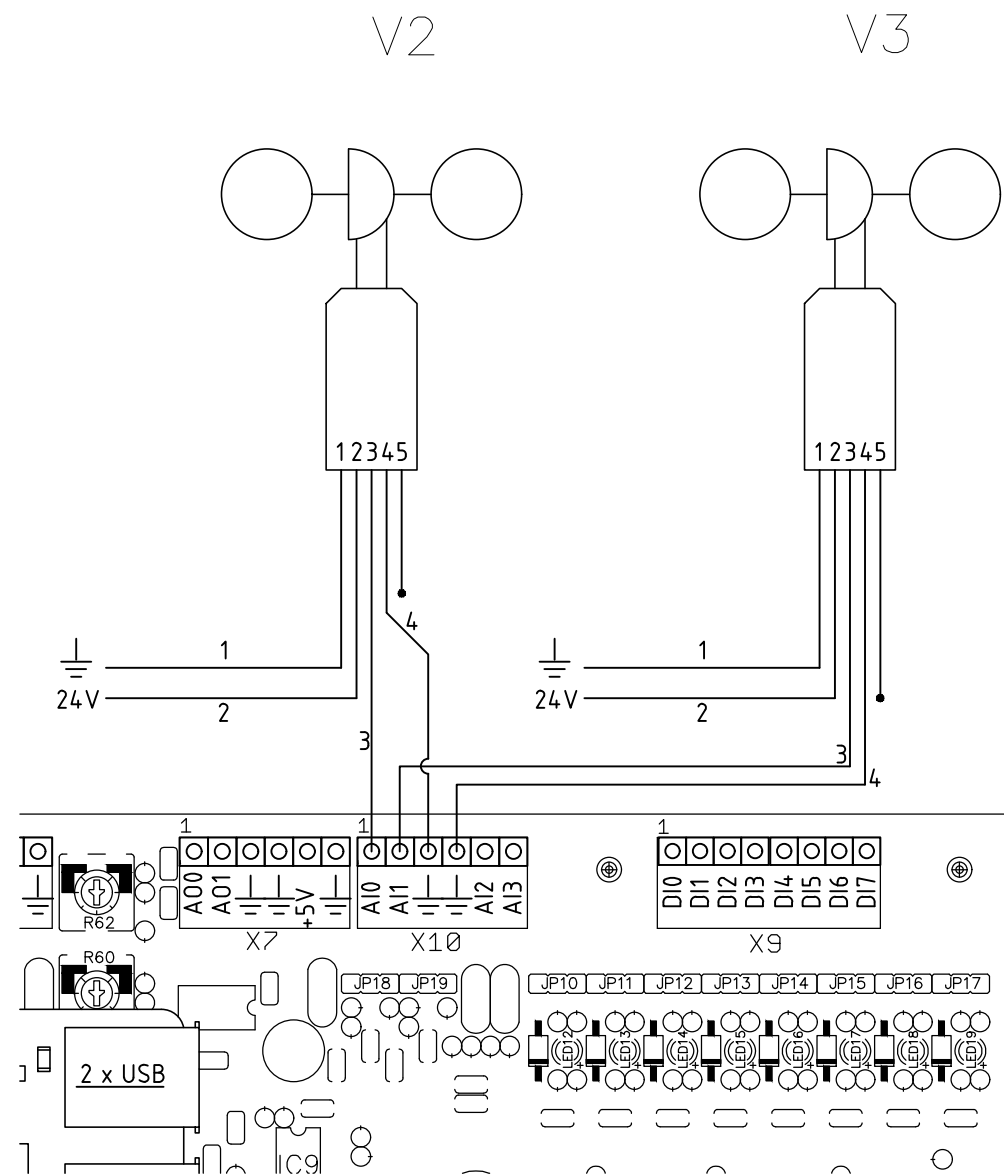

Tilslutning af ekstra vindsensorer

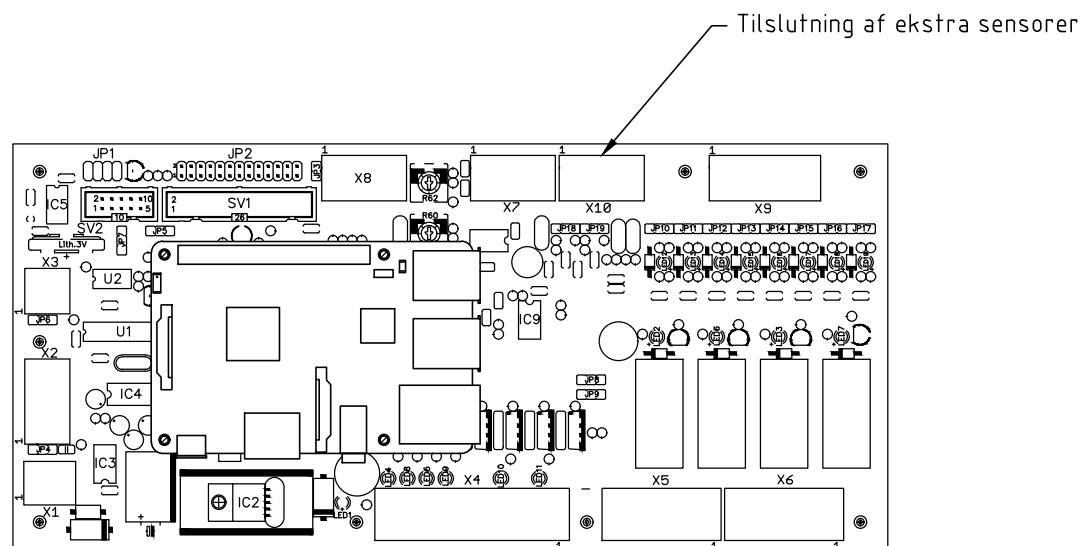

		Forhandles af:		Revision:	Sags.nr.:
		Blendex A/S	blendex.dk		
Sag: Principdiagram SynSync 240 Emne: Tilslutningsdiagram Sunsunc 240 ekstra sensorer		Fischer Danmark A/S		STANDARD	
		Mål: -	Dato: 11.11.17	Tegn.nr.:	
		Sign.: PC		240-08	

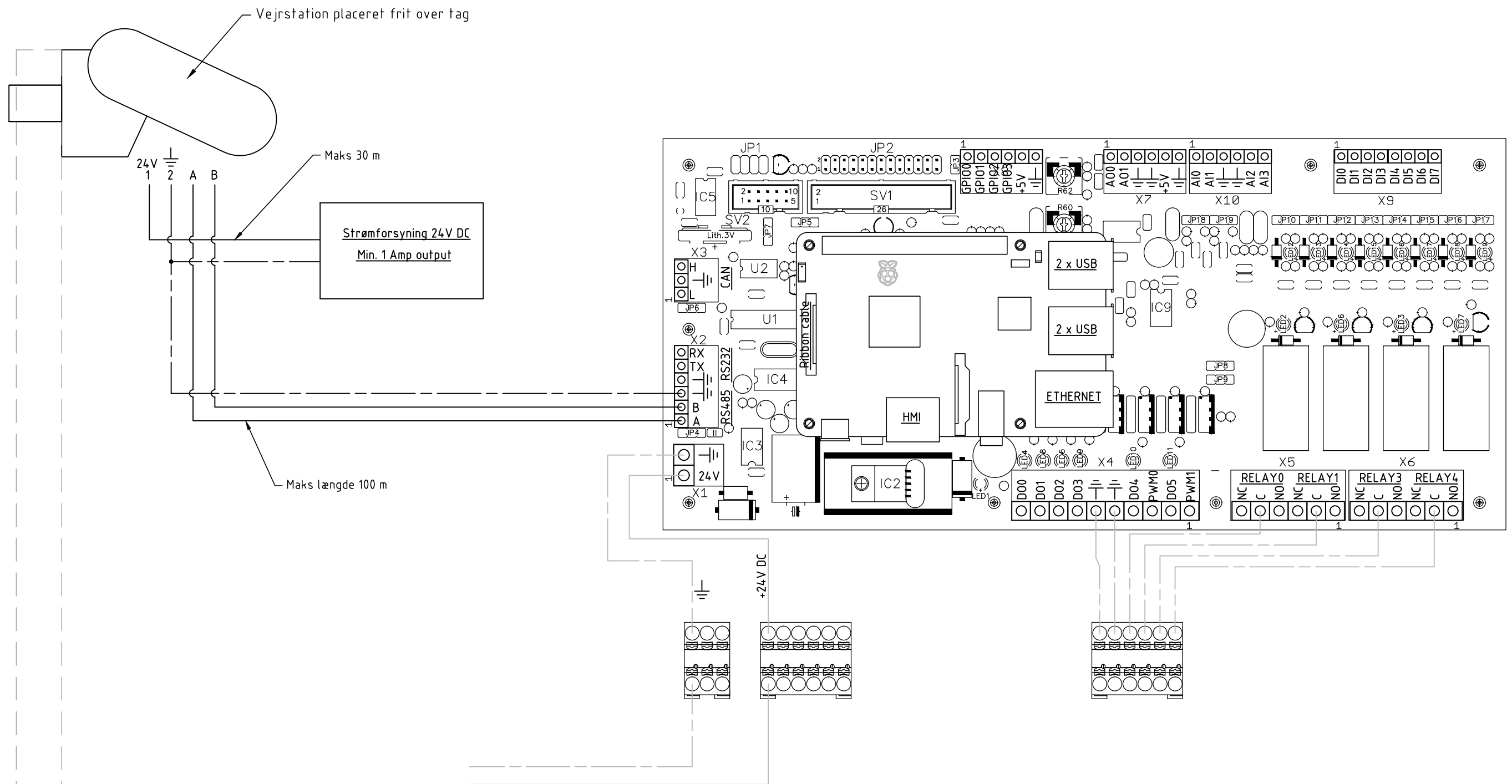

		Forhandles af:	
		Blendex A/S Fischer Danmark A/S	blendex.dk fischer-danmark.dk
Sag: Principdiagram SynSync 240		Revision:	Sags.nr.:
Emne:		Mål: -	A: STANDARD
Tilslutning af vejrstation		Dato: 11.11.17	C: Tegn.nr.:
kabel længde > 30 m		Sign.: PC	D: 240-09
		E:	

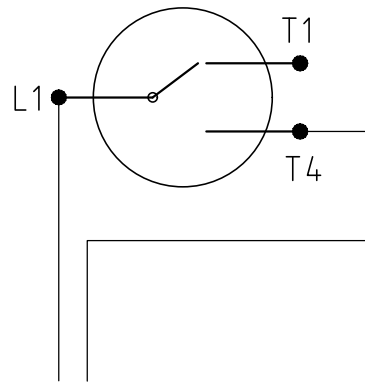

Til styrecentral

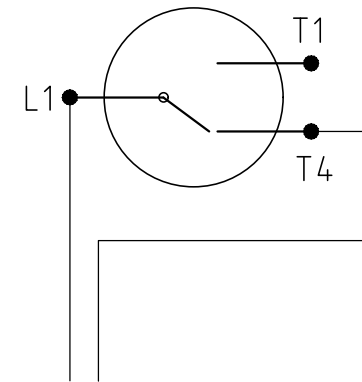

Til styrecentral

Vinduespudserafbryder i normal position

Vinduespudserafbryder i blokeret position

Lås excl Blendex

		Forhandles af:	
		Blendex A/S Fischer Danmark A/S	blendex.dk fischer-danmark.dk
Sag: Principdiagram SynSync 240		Revision:	Sags.nr.:
Emne:		A:	STANDARD
Tilslutning af vinduespudserafbryder		B:	
Sunsync 240		C:	Tegn.nr.:
		D:	240-10
		E:	
		Mål: _	
		Dato: 11.11.17	
		Sign.: PC	

Markise

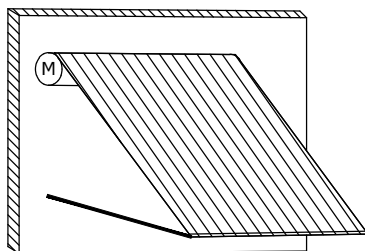

Screen

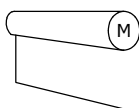
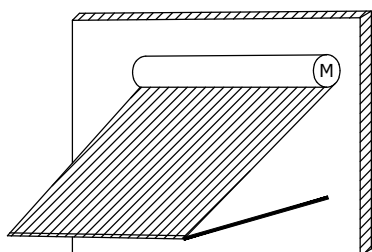
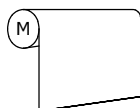

Markise

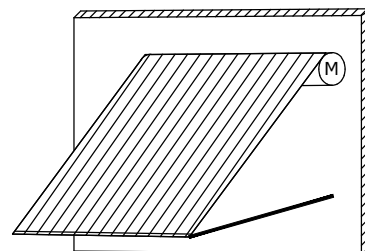

Screen

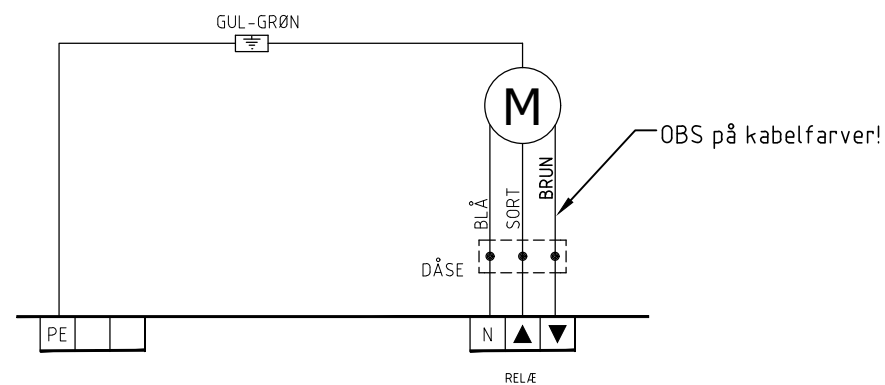
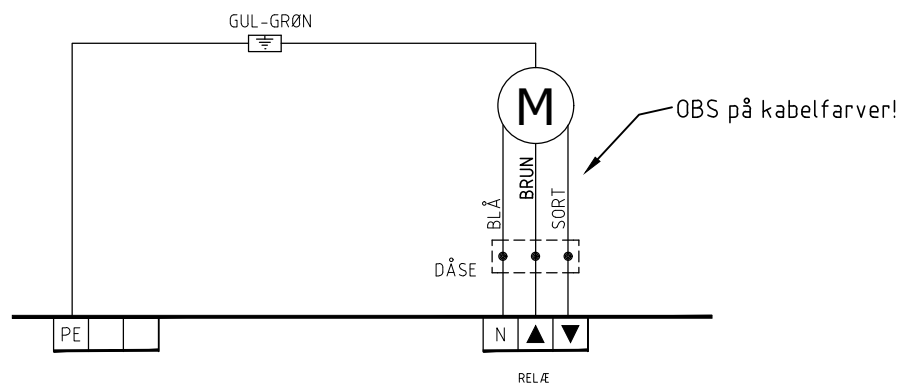
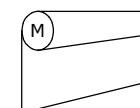
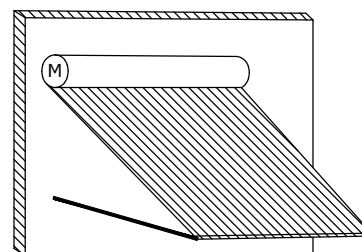

sunsync™

Forhandles af:

Blendex A/S
Fischer Danmark A/S

blendex.dk
fischer-danmark.dk

Sag: Principdiagram SynSync 240

Emne: Motortilslutning i relæ
Eksempler med forskellige motorsider m.m.

Mål: _
Dato: 11.11.17
Sign.: PC

Revision:
A:
B:
C:
D:
E:

Sags.nr.:
STANDARD
Tegn.nr.:
240-11